

Recommendations to Industry Arising from Investigation of Fractured Plate Girders and Associated Studies at the Transbay Transit Center, San Francisco

February 14, 2020

Prepared by:

Michael Engelhardt – University of Texas at Austin (Peer Review Panel Chair)
John Fisher – Lehigh University, Emeritus
Brian Kozy – Federal Highway Administration
Thomas Sabol – Englekirk Structural Engineers
Robert Shaw – Steel Structures Technology Center
William Mohr – Edison Welding Institute (consultant to Peer Review Panel)
Stephen Wolf – Metropolitan Transportation Commission (Peer Review Panel manager)

Introduction

The Transbay Transit Center (TTC) in San Francisco, also known as the Salesforce Transit Center, was first opened to the public in August of 2018. On September 25, 2018, a worker installing ceiling panels observed a crack in a steel girder. The TTC was closed that same day. Subsequent inspections revealed major fractures in two steel girders spanning over Fremont Street. The discovery of these fractures initiated a series of actions to determine the cause of the fractures, develop and implement repairs for the fractured girders, and re-evaluate other safety-related aspects of the TTC structural system. These activities were largely completed in early summer of 2019, leading to reopening of the TTC on July 1, 2019.

Following discovery of the fractured girders, the mayors of San Francisco and Oakland asked the Metropolitan Transportation Commission (MTC) to assemble an independent Peer Review Panel (PRP) to review a number of activities and studies related to the fractures. The PRP's conclusions regarding these tasks are summarized in a series of letters submitted to MTC. A final task undertaken by the PRP was to consider broader lessons learned from this incident and to provide recommendations on actions that can be taken to avoid such an incident in the future on other structures. This report is the documentation of this final task. The authors of this report are the members of the PRP, a consultant to the PRP, and the MTC PRP manager, all of whom are listed above.

The objective of this report is to provide recommendations on actions that can be taken that may help mitigate the future occurrence of brittle fractures. The authors were not assigned to review the contracts between TJPA and its consultants and contractors for the purpose of assigning culpability for the fractured girders at the TTC, nor have they done so. This report, therefore, does not address issues of culpability, and information in this report should not be construed as representing the opinion of the authors or of MTC in matters regarding culpability.

The focus of the recommendations provided in this report are technical issues associated with the PRP's scope of review, described below. Valuable recommendations may arise from other background material from this incident that was outside of the PRP's scope of review, such as procedural, administrative, and compliance considerations. The authors hope other professionals involved in the TTC girder fractures investigation and repair will contribute their expertise and experiences from this incident to the discussions on mitigating such failures in the future.

Background on the MTC PRP

The PRP was convened by MTC at the request of the mayors of San Francisco and Oakland and initiated work in mid-October of 2018. The purpose of the PRP was to provide an independent technical review of work done in response to the fractured girders by the owner of the TTC, the Transbay Joint Powers Authority (TJPA), and TJPA's project team and consultants. As such, the PRP did not undertake an independent investigation of the fractured girders, but instead reviewed the work done by others. The focus of the PRP was on technical issues and on structural safety.

The review undertaken by the PRP was divided into the following seven phases:

1. Capacity of the temporary shoring systems.
2. Sampling and testing plan for material from the fractured steel girders.
3. Cause of failure.
4. Impact of fractures on adjacent elements.
5. Repair of Fremont Street girders.
6. Search for other areas susceptible to brittle fracture.
7. Review of TJPA's fatigue assessment plan.

The completion of each phase was documented by a letter from the PRP to MTC. These letters are available as a matter of public record.

The recommendations provided in this report are based on information gained through this review process as well as on the expertise, experience, and professional judgement of the authors of this report.

LPI Report on Cause of Failure

To determine the cause of the TTC girder fractures, TJPA hired LPI, Inc. of New York City (henceforth referred to as “LPI”). LPI’s work included field observations, metallurgical examinations and testing of steel samples removed from the girders, advanced finite element simulations, and fracture mechanics analyses of the girders. The PRP reviewed many aspects of the work done by LPI and reviewed draft reports and the final report issued by LPI. The final report issued by LPI, henceforth referred to as the “LPI Report,” is as follows:

“Root Cause and Fitness-for-Service Assessments of TPG3 Fractured Girders, Salesforce Transit Center, San Francisco, CA” Document LA181690-R-002 Rev. 1, prepared by LPI, Inc., dated November 12, 2019.

The LPI report provides detailed information on the location and nature of the fractures and a detailed assessment on the cause of the fractures. Only a few key salient features of the fractured girders and of the cause of the fractures are summarized below to provide context to the recommendations provided at the end of this report.

Overview of TPG3 Girders

The girders that fractured at the TTC were designated in the design drawings as “TPG3” girders, where TPG refers to Tapered Plate Girder. There was a total of four TPG3 girders in the TTC, and all four had nominally identical designs. Two TPG3 girders spanned over Fremont Street and two TPG3 girders spanned over First Street. It was the two TPG3 girders that spanned over Fremont Street that fractured. All four TPG3 girders spanned in approximately the east-west direction. The TPG3 girders over Fremont Street spanned along gridlines D.4 and E.6 as indicated on the design drawings. The TPG3 girders over First Street spanned along gridlines D and F.

Each TPG3 girder, approximately 87-ft. in length, is a single span. The girder cross-section is a welded I-shape, with an overall depth of 8-ft. at midspan and with a linear reduction in depth to approximately 5-ft. at each end. The top flange is horizontal whereas the bottom flange on each half of the girder is inclined to provide for the tapered depth. Both the top and bottom flanges are 36-in. wide and 4-in. thick along the entire length of the girder. The web plate is 1.5-in. thick with a varying depth. The web is connected to the flanges using fillet welds. Figure 1 shows a sketch of the TPG3 girder in elevation, and Figure 2 shows a typical cross-section.

The TPG3 girders are part of the gravity load resisting system of the structure but are not part of the seismic load resisting system. The girders are located at the roof level of the structure and support gravity loads from the rooftop park. A unique feature of the TPG3 girders is that a hanger extends from the girder midspan down to the bus level of the TTC. Thus, the TPG3 girders provide support for both the rooftop park and for the bus level below.

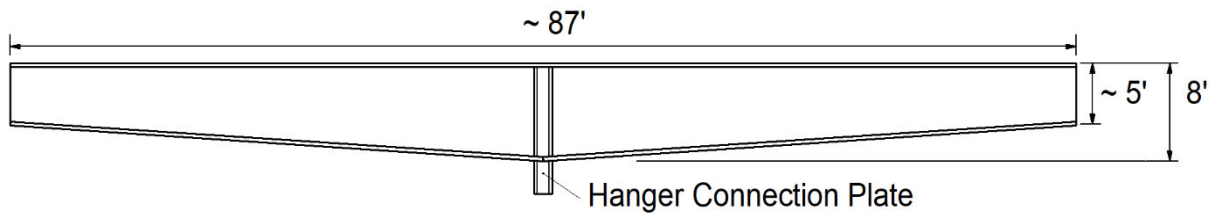

Figure 1 – Overall Dimensions of TPG3 Girder

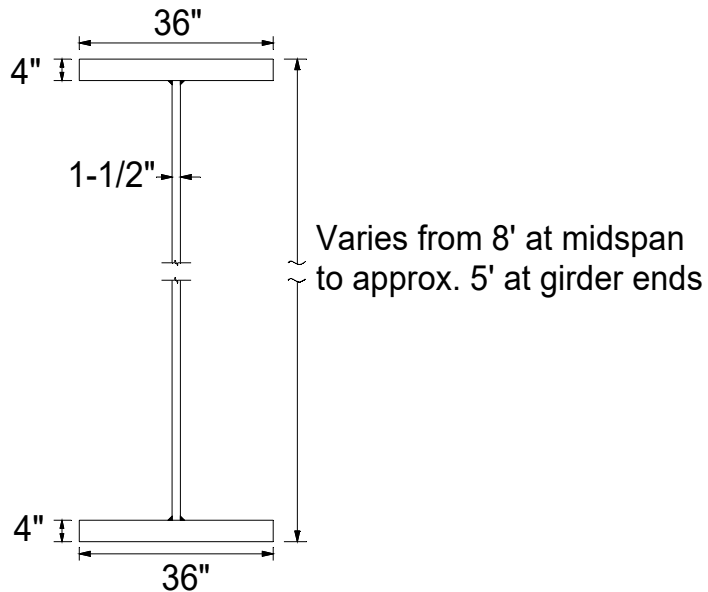

Figure 2 – Typical Cross-Section of TPG3 Girder

The hanger assembly includes an integral hanger connection plate, angles, and a wide flange member. The hanger connection plate is 18-in. wide by 4-in. thick and approximately 10-ft. 3-in. in length. The 4-in. plate thickness is tapered to 1.5-in. at each side of the 18-in. width to match the 1.5-in. TPG3 web plate thickness. Figure 3 shows the hanger connection plate cross-section. The hanger connection plate also serves as the web of TPG3 at midspan and is welded to the adjoining 1.5-in. web plates by complete joint penetration (CJP) groove welds. The hanger connection plate starts at the bottom side of the top flange, extends downward over the full depth of the girder, passes through a slot cut in the bottom flange, and extends below the girder approximately 31-in. Fillet welds were provided between the hanger connection plate and the bottom side of the top flange, and between the hanger connection plate and the top and bottom sides of the bottom flange. Angles are bolted to the protruding portion of the hanger connection plate that then connect to a wide-flange member that extends down to the bus level.

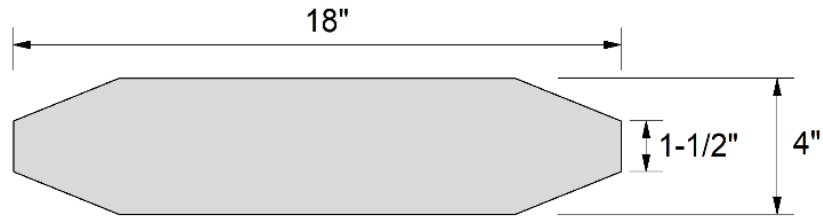

Figure 3 – Hanger Connection Plate Cross-Section

At midspan of the girder, at the location where the hanger connection plate protrudes from the bottom of the girder, the 4-in. thick bottom flange plates on either side of midspan were connected by a CJP groove weld. The CJP groove weld was not continuous over the 36-in. width of the flange, as the weld was interrupted by the hanger connection plate. In addition, at midspan, 2-in. thick full-depth stiffeners were provided in the girder. The stiffeners were attached to the top flange, to the hanger connection plate, and to the bottom flange by fillet welds. The bottom of the stiffener was located approximately over the CJP groove weld in the bottom flange.

Figure 4 is a sketch of the TPG3 girder at midspan showing the hanger connection plate. This figure also shows the location of the CJP groove weld in the bottom flange and the CJP groove welds connecting the 1.5-in. thick girder web to the 1.5-in. thick edges of the hanger connection plate. Fillet welds connecting the girder flanges to the girder web, fillet welds connecting the stiffener to the girder flanges and to the hanger, and fillet welds between the hanger connection plate and top and bottom side of the bottom flange and the bottom side of the top flange are not shown. Figure 5 is a photo of a TPG3 girder that was taken during construction of the TTC. Figure 6 is a similar photo with labels identifying several features.

At midspan, the bottom flange of each TPG3 girder had thermally cut slots. A schematic representation of these slots is shown in Figure 7, which is a view looking down on the bottom flange. The figure also shows a cross-section of the 4-in. thick bottom flange. This figure should be considered as a qualitative representation, and is not intended to accurately represent all features or dimensions. The north arrow shown in the figure does not coincide with compass north at this location, but is intended to serve as a reference and coincides with the direction of Fremont Street.

One of the slots in the bottom flange conforms to the shape of the hanger connection plate and allows the hanger connection plate to pass through the bottom flange. In this report, this slot is referred to as the “primary slot.” Two additional slots were cut into the bottom flange in the region where the CJP groove weld approaches the hanger connection plate. These slots, which are approximately rectangular in shape, are referred to in this report as “secondary slots.” Each secondary slot was approximately 5-in. in length and 2-in. in width. There is a secondary slot on either side of the primary slot. A secondary slot is visible in the photo of the TPG3 girder in Figure 6.

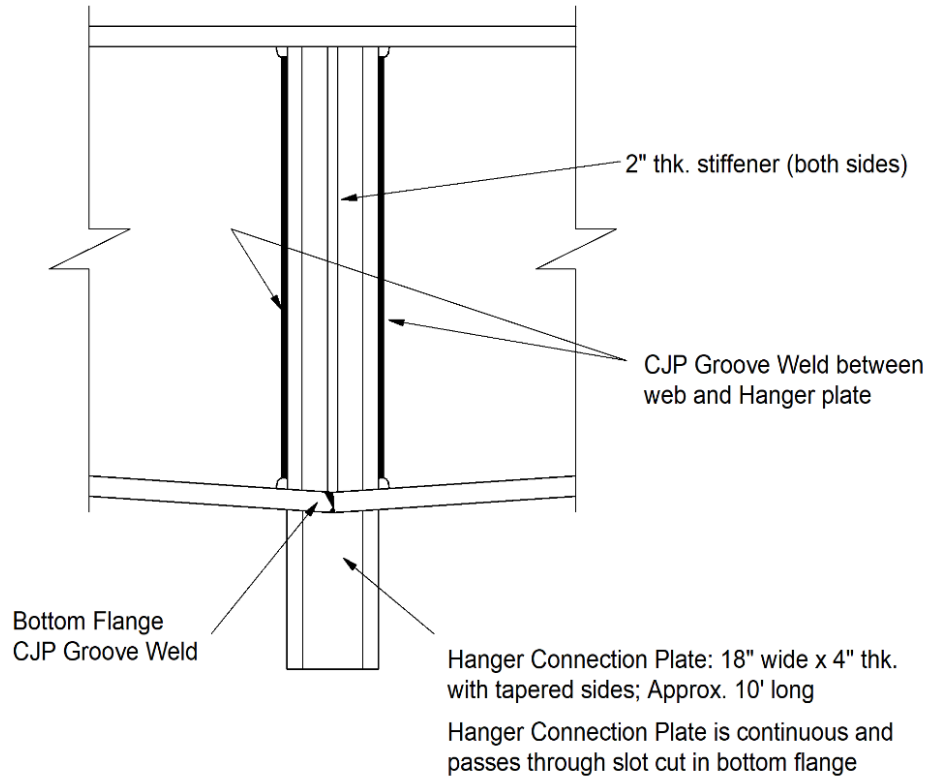

Figure 4 – TPG3 Girder at Mid-Span



Figure 5 – Photo of a TPG3 Girder during Construction of the TTC (Photo: TJPA)

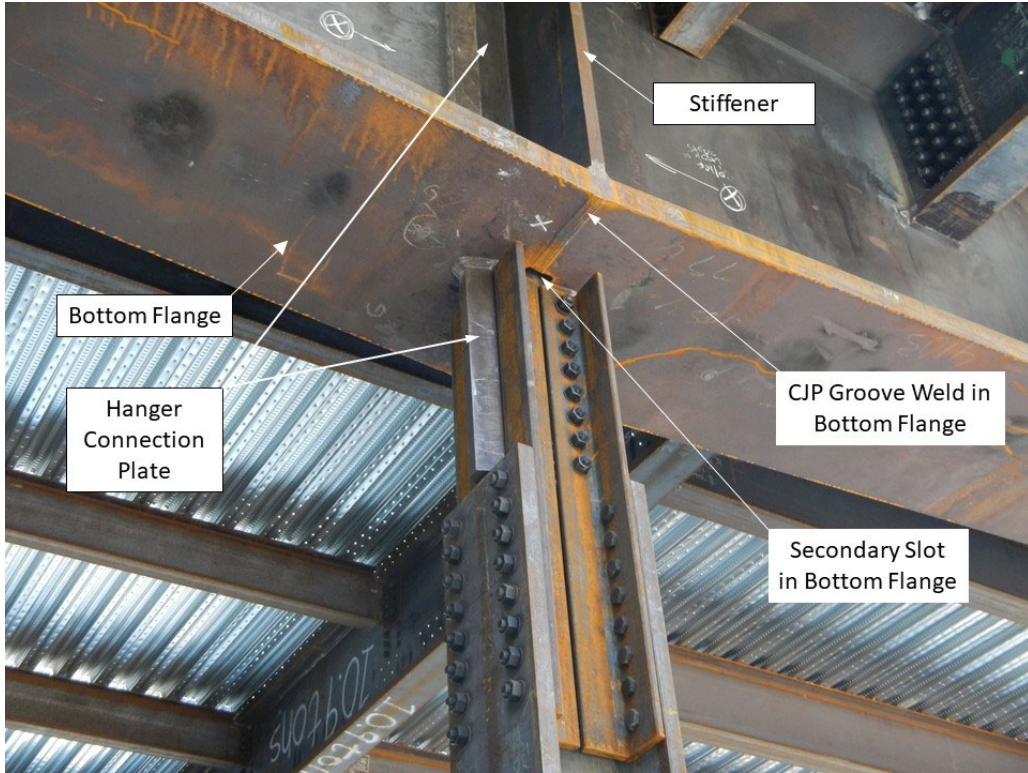

Figure 6 – Photo of a TPG3 Girder with Labeled Features (Photo: TJPA)

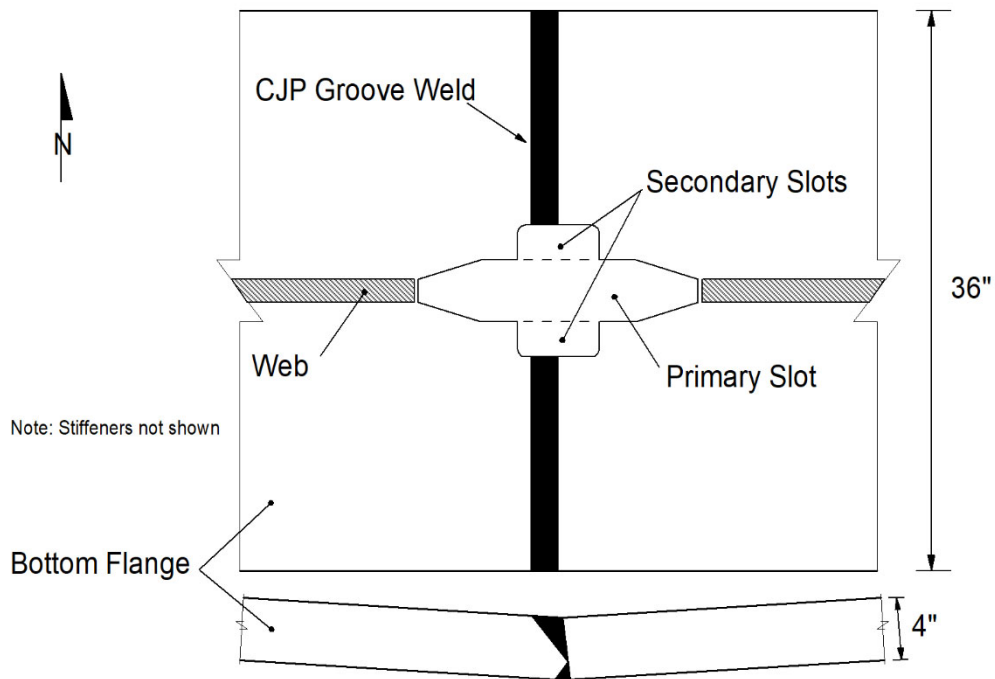

Figure 7 – Schematic Representation of the Bottom Flange near Midspan of TPG3 Girders

Figure 7 also schematically shows the CJP groove weld in the bottom flange. Based on the detailing of this CJP groove weld, the volume of the weld was somewhat offset towards the west end of the secondary slots.

To the understanding of the PRP, the secondary slots were added to avoid terminating the CJP groove weld at the face of the hanger connection plate, where the hanger connection plate might serve as an “end dam” for the weld, with the potential for weld discontinuities at this location. The secondary slots were therefore presumably added to allow sound termination of the CJP groove weld.

A difference in the TPG3 girders at First Street and at Fremont Street was when the secondary slots were cut in the overall fabrication sequence of the girders. For the First Street TPG3 girders, the CJP groove weld was made before the secondary slots were cut. That is, the CJP groove weld was placed up to the face of the hanger connection plate. Afterwards, the secondary slots were cut into the bottom flange. For the Fremont Street girders, the secondary slots were cut before production of the CJP groove weld. Thus, the secondary slots were already present at the time of welding. As will be discussed later, the difference of when the secondary slots were cut into the bottom flange likely played a key role in why the Fremont Street girders fractured and the First Street girders did not.

An additional difference between the TPG3 girders at First Street and at Fremont Street was the extent of the fillet welds connecting the hanger connection plate to the top and bottom sides of the bottom flange. At First Street, the fillet welds wrapped around the entire hanger connection plate except for the region of the secondary slots. The fillet weld between the hanger connection plate and the bottom side of the bottom flange is visible in Figure 6, which is a photo of a TPG3 girder at First Street. At Fremont Street, the fillet welds did not continue along the 1.5-in. thick regions at the ends of the 18-in. wide hanger connection plate. The LPI analysis indicates that this difference in the fillet welds did not play a significant role in why the Fremont Street girders fractured and the First Street girders did not.

The 4-in. thick by 36-in. wide plates used for the flanges of the TPG3 girders were specified and supplied as ASTM A572 Gr. 50 steel. This steel was also specified to be subject to Charpy V-notch (CVN) testing as required in Section A3.1d on “Built-Up Heavy Shapes” of the *AISC Specification for Structural Steel Buildings* (Standard ANSI/AISC 360). This specification will be referred to as “AISC-360” herein.

Description of Fractures

As described earlier, a fracture in the bottom flange of a TPG3 girder over Fremont Street was discovered on September 25, 2018. Subsequent inspections revealed that both TPG3 girders over Fremont Street had fractured bottom flanges. No fractures were found in the TPG3 girders over First Street. The exact date and time that the fractures occurred is unknown, although the LPI Report estimates the fractures occurred between the end of February 2018 and the end of April 2018.

Figure 8 shows a simplified schematic representation of the fracture locations for the TPG3 girders along gridlines D.4 and E.6. For the girder on gridline D.4, fractures extended essentially over the full width of the flange. For the girder on gridline E.6, a fracture extended over half the width of the flange. In the descriptions that follow, the TPG3 girder on gridline D.4 is also referred to as the *North Girder*, and the TPG3 girder on gridline E.6 is also referred to as the *South Girder*.

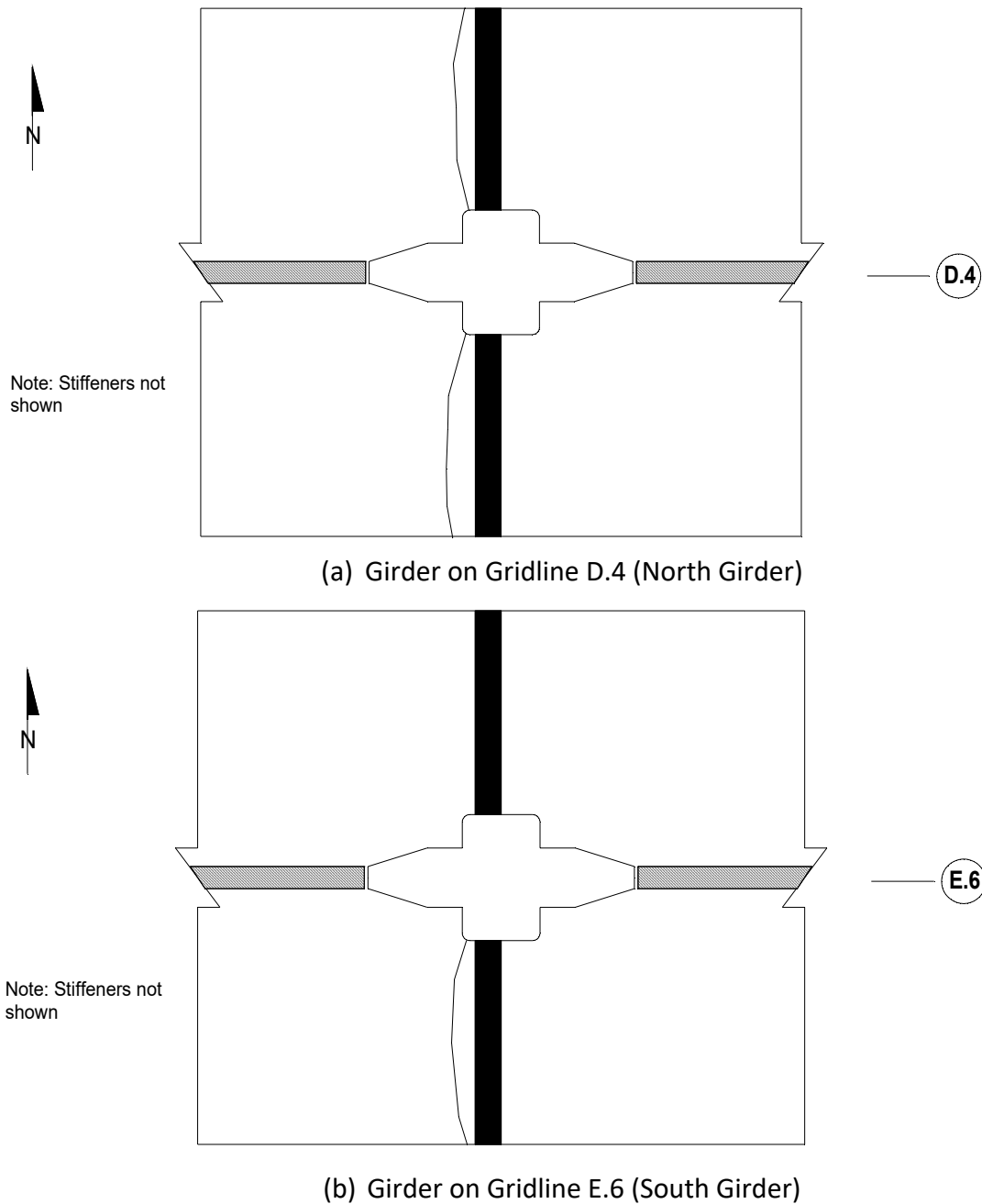

Figure 8 – Schematic Representation of Fracture Locations in Bottom Flanges of TPG3 Girders at Fremont Street (view looking down at upper side of bottom flanges)

Figures 9 through 15 are photos of the fractures. Arrows have been added to the photos to highlight the fracture locations. The lines drawn on the girders in Figures 11 and 15 denote cut locations for removal of portions of the girders for subsequent examination and material testing. Figure 16 is a photo of the north half of the South Girder, where no fracture occurred. Figure 17 is a photo of a portion of the north half of the North Girder after removal. Figure 18 is a photo of the fracture surface in the south half of the South Girder.

Observations showed that the bottom flange fractures in the TPG3 girders over Fremont Street initiated at the reentrant corners of the secondary slots and extended to the outer edge of the flange. All three fractures initiated at the west end of the secondary slots. The location of fracture initiation in the secondary slots, although close to the CJP groove weld, was within the base metal rather than in the weld. As described in the LPI Report, the fracture surfaces were characteristic of brittle fractures. The LPI Report provides numerous additional photos of the fractures and fracture surfaces.



Figure 9 – North Girder - View Looking East (Photo: TJPA)



Figure 10 – North Girder – North Half - View Looking South (Photo: TJPA)



Figure 11 – North Girder – North Half – View Looking Southeast (Photo: TJPA)



Figure 12 – North Girder – South Half - View Looking North (Photo: TJPA)



Figure 13 – North Girder – South Half - View Looking Northeast (Photo: TJPA)



Figure 14 – South Girder – South Half - View Looking North (Photo: TJPA)

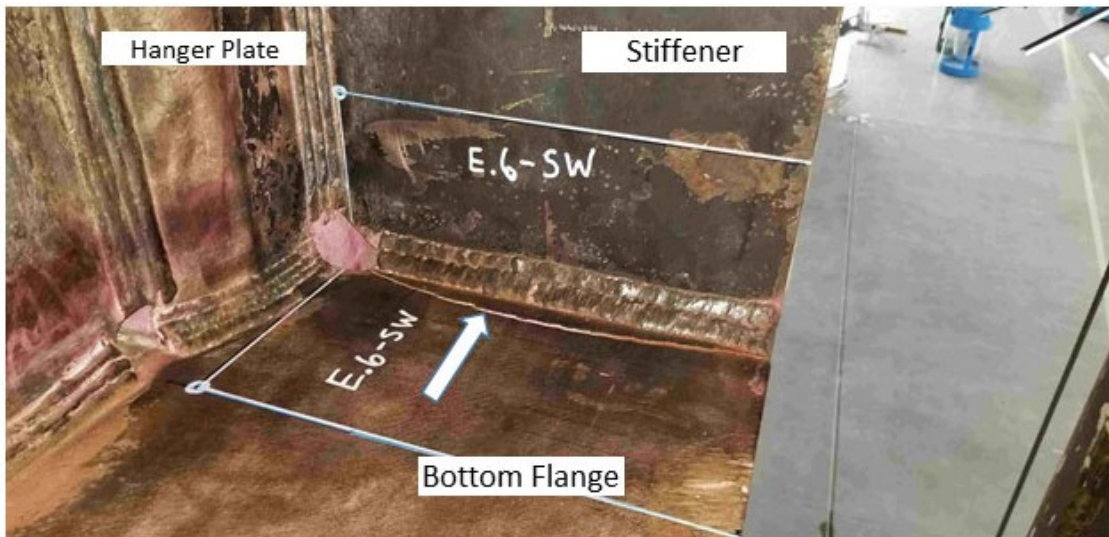

Figure 15 – South Girder – South Half - View Looking East (Photo: TJPA)



Figure 16 – South Girder – North Half - View Looking South – No Fracture (Photo: TJPA)

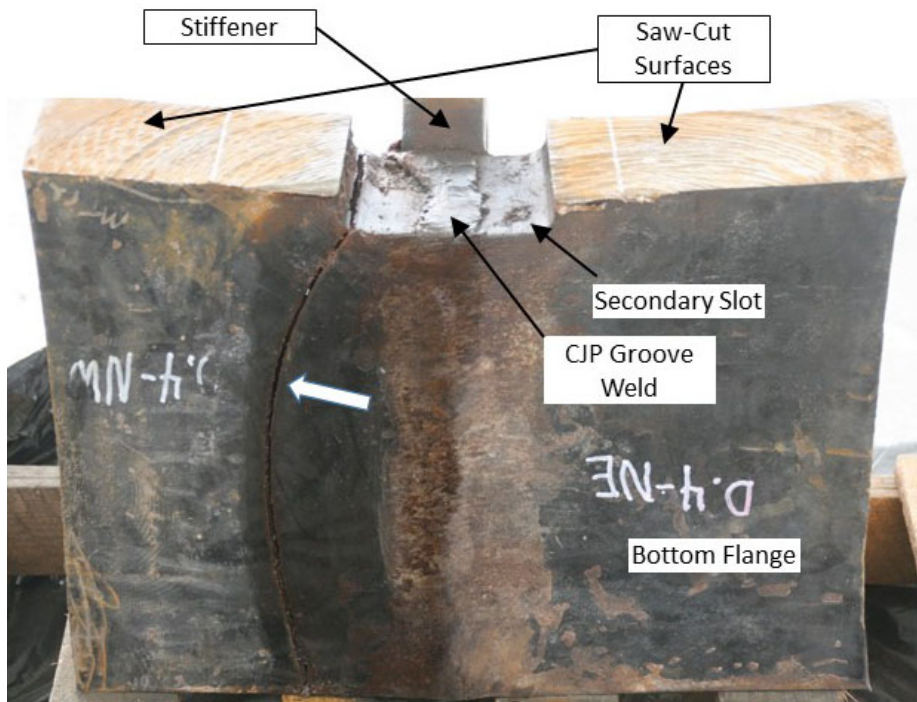

Figure 17 – North Girder – North Half Flange – After Removal (Photo: R. Shaw)



Figure 18 – Fracture Surface – South Half of South Girder (Photo: LPI Report)

Failure Hypothesis

LPI undertook an extensive study on the cause of the fractures. This work is documented in detail in the LPI Report. Based on the work conducted by LPI, the basic failure hypothesis on factors leading to the brittle fractures in the TPG3 girders at Fremont Street can be summarized as follows:

- Thermal cutting of the secondary slots in the girder bottom flange produced microcracks in the radii of the reentrant corners of the secondary slots at mid-thickness of the bottom flange plate near the bottom flange CJP groove weld. Figure 19 is a photo from the LPI Report showing the microcracks. The thermal cutting process resulted in microcracks in a thin layer of hard martensitic material on the surface of the secondary slot. The depth of the martensitic layer and the depth of the microcracks were on the order of several hundredths of an inch.
- Some of the microcracks in the reentrant corners later became larger “pop-in” cracks at the mid-thickness of the girder’s bottom flange plate, with a depth on the order of 3/8-in. Pop-in cracks were observed in the north half of the North Girder and the south half of the South Girder but were not observed in the south half of the North Girder. Figure 20 is a photo from the LPI report highlighting the location of the pop-in crack at mid-depth of the flange for the south half of the South Girder. This pop-in crack is also visible on the fracture surface in Figure 18. These pop-in cracks likely occurred due to tensile stresses generated by weld area shrinkage from production of the complete joint penetration groove weld in the bottom flange. The formation of the pop-in cracks was likely facilitated by the very close proximity of the secondary slot reentrant corners to the CJP groove weld on the west end of

the secondary slots (see Figure 7). The LPI Report shows the tensile stresses from weld area shrinkage being concentrated around the reentrant corners.

- Sometime after the girders were erected, brittle fracture of the bottom flange occurred, initiating at the pop-in crack in the radius of the secondary slot at mid-thickness of the bottom flange plate and extending to the outer edge of the flange.
- Pop-in cracks were observed at the fracture initiation locations for the brittle fractures on the north side of the North Girder and the south side of the South Girder. A pop-in crack was not observed at the fracture initiation site for the brittle fracture on the south side of the North Girder. This fracture initiated at a microcrack. The LPI Report surmises that the brittle fracture on the south side of the North girder may have initiated due to dynamic loading effects caused by the fracture of the north side of the North girder and the redistribution of load from the north side to the south side of the girder. The dynamic loading effectively reduces the fracture toughness of the steel, allowing brittle fracture to initiate at a smaller initial discontinuity than under quasi-static loading.
- The stress in the bottom flange that initiated the brittle fracture was a combination of:
 - Residual stresses from the welding of the complete joint penetration groove weld in the bottom flange;
 - Stresses from loads on the TPG3 girders after erection; and
 - A stress concentration caused by the reentrant corner of the secondary slot.
- The girder fractures were facilitated by the significantly low fracture toughness of the steel near mid-thickness of the 4-in. thick bottom flange.

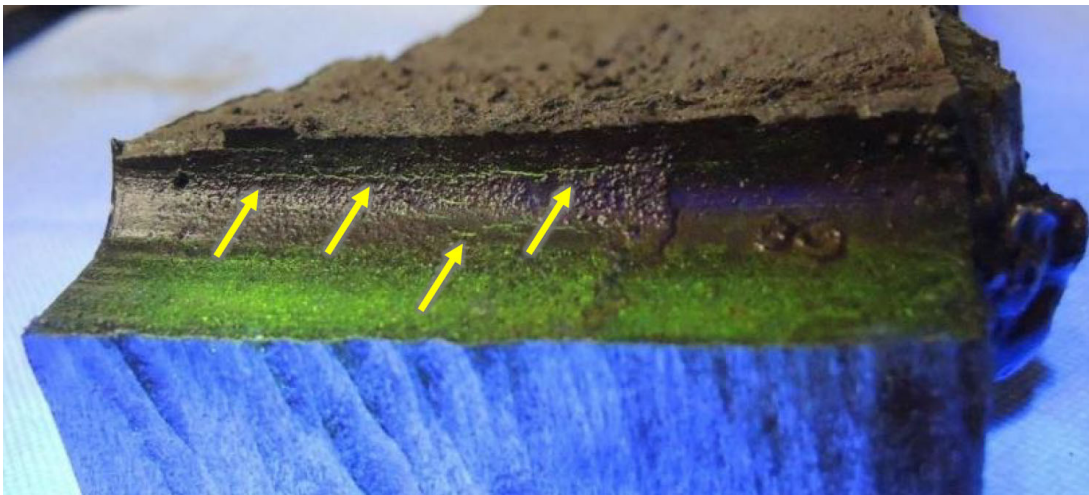

Figure 19 – Microcracks on Radius of Reentrant Corner of Secondary Slot on South Half of North Girder – Crack Visibility Enhanced by Florescent Magnetic Particle Testing (Photo: LPI Report)



Figure 20 – Pop-in Crack (covered by dark oxide) near Mid-depth of Bottom Flange at South Half of South Girder (Photo: LPI Report)

LPI conducted many Charpy V-notch (CVN) tests on samples of steel removed from the fractured girders, in the area close to the fractures. CVN tests provide an indirect measure of fracture toughness. For the Fremont Street girders, CVN tests were conducted at four temperatures: 100 °F, 70 °F, 30 °F, and 0 °F. This provides data on the variation of CVN values over a range of temperatures and is not intended to imply the fractures necessarily occurred at any of these temperatures. CVN samples were prepared at five different locations through the depth of the 4-in. thick bottom flange plates: top surface of the plate, bottom surface of the plate, one-quarter of the plate thickness from the top (i.e., 1-in. from the top surface), three-quarters of the plate thickness from the top (i.e., 1-in. from the bottom surface), and at mid-thickness of the plate. Not all five locations were tested at all four temperatures. The data for 70 °F, 30 °F, and 0 °F is summarized in the plots in Figures 21 to 23. The data is also summarized in Table 1. Note that no tests were conducted at mid-thickness of the plate at 0 °F.

LPI also conducted a smaller number of CVN tests on samples removed from the bottom flange of the TPG3 girders at First Street and from the hanger connection plates in the Fremont and First Street girders. This data is provided in the LPI Report and is not reproduced here.

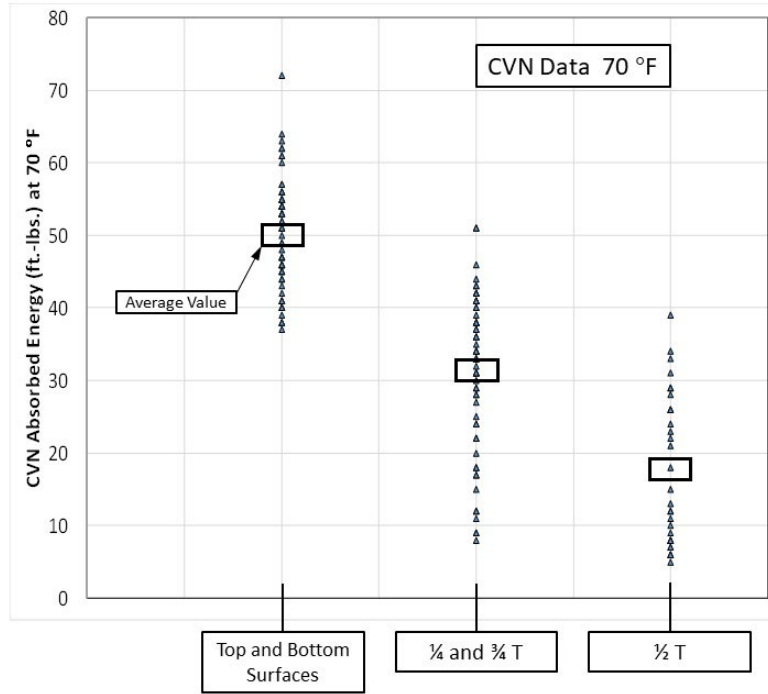

Figure 21 – CVN Data for Steel Samples Removed from Fremont Street Girders
Test Temperature = 70 °F (Data from LPI Report)

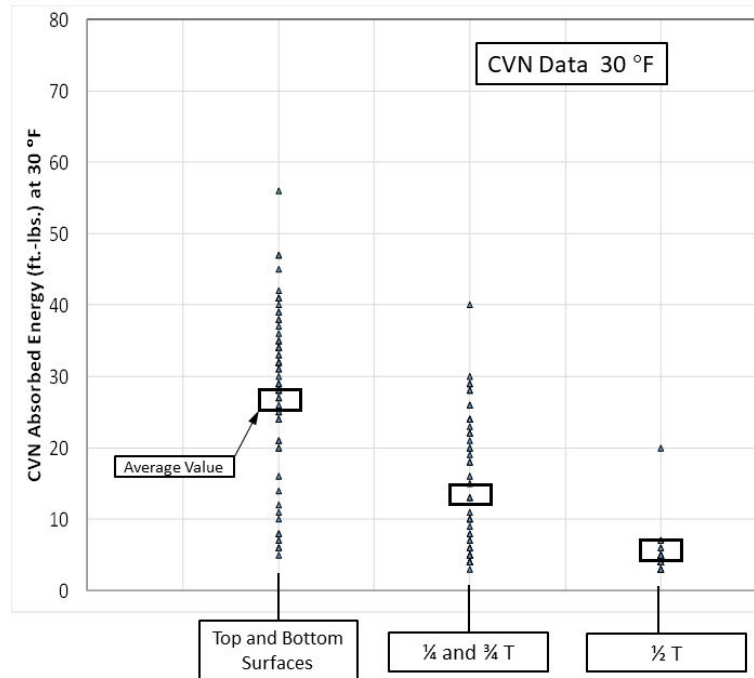

Figure 22 – CVN Data for Steel Samples Removed from Fremont Street Girders
Test Temperature = 30 °F (Data from LPI Report)

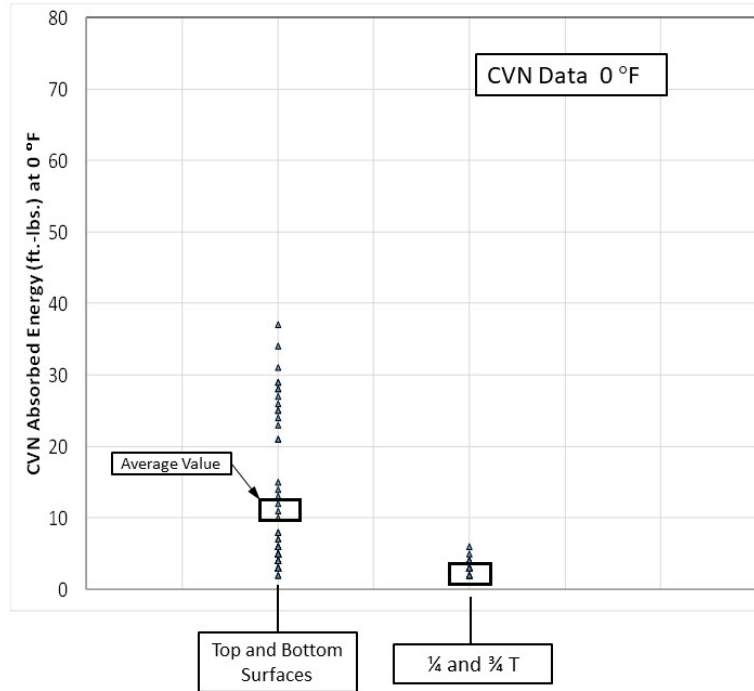

Figure 23 – CVN Data for Steel Samples Removed from Fremont Street Girders
 Test Temperature = 0 °F (Data from LPI Report)

Sample Location	Test Temperature								
	70 °F			30 °F			0 °F		
	No. of Samples	Avg CVN	Std Dev	No. of Samples	Avg CVN	Std Dev	No. of Samples	Avg CVN	Std Dev
		ft-lbs			ft-lbs			ft-lbs	
T & B Surfaces	64	50	8	64	28	12	64	11	10
¼ and ¾ T	64	31	11	64	13	9	40	3	1
½ T	32	18	10	32	5	3			

Table 1 – Summary of CVN Data for Fremont Street Girders (Data from LPI Report)

As described earlier, the TPG3 girders at First Street were nominally identical to the TPG3 girders at Fremont Street. However, the TPG3 girders at Fremont Street fractured whereas those at First Street did not. CVN testing of material samples taken from the bottom flanges of the Fremont and First Street girders exhibited low values at mid-thickness, although the CVNs at First Street were perhaps somewhat higher. However, the key factor differentiating First Street from Fremont Street appears to be when the secondary slots were cut during the fabrication and welding sequence for the girders. At First Street, the secondary slots were cut after completion of the CJP groove weld in the bottom flange. The radii of the secondary slots showed microcracks, similar to Fremont Street. Analysis presented in the LPI report indicates that the weld shrinkage stresses in the radii of the secondary slots at First Street were significantly reduced, compared to the Fremont Street girders, because they were cut into the flange after welding. Consequently, microcracks in the radii of the secondary slots at First Street did not generate larger pop-in cracks. This is supported by observations at First Street that showed no pop-in cracks.

Lessons Learned and Recommendations

This section discusses broad lessons learned from the TTC brittle fractures and recommendations on steps that can be taken to avoid such brittle fractures in the future. These recommendations are intended for industry groups, standards writing organizations, and other stakeholders. These recommendations should not be construed as representing the opinion of the authors or of MTC in matters regarding culpability. As described earlier, the focus of these recommendations are technical issues associated with the PRP scope of review.

In general, the likelihood of brittle fracture in steel elements is affected by the fracture toughness of the steel, sharp discontinuities in the element, and stress levels. There are trade-offs between these factors. For example, steel with higher fracture toughness can tolerate larger discontinuities and larger stresses. Likewise, elements with smaller discontinuities and smaller stress levels can permit the use of steel with lower fracture toughness, etc.

In normal design practice for steel building structures, designers do not undertake fracture mechanics calculations to quantitatively evaluate brittle fracture limit states. Rather, the intent is to eliminate brittle fracture as a potential limit state. This is normally done by appropriate specification of materials, appropriate production and fabrication techniques, and appropriate design and detailing. In this regard, designers rely on the collective knowledge of the industry as represented in our building codes and standards, combined with their professional knowledge and experience. Fortunately, brittle fractures in major steel structures, such as the fractures that occurred at the TTC, are relatively rare events. The fractures at the TTC can be viewed as the result of a confluence of factors contributing to brittle fracture.

The brittle fractures at the TTC will add to the knowledge and experiences of the industry, and will hopefully lead to improvements in our codes, standards, and practices to

further minimize the occurrence of brittle fractures in the future. It is in this spirit of learning and improvement that these recommendations are offered.

1. Specification of Steel CVN Requirements

The AISC 360 *Specification for Structural Steel Buildings* specifies CVN requirements for “Built-Up Heavy Shapes,” in Section A3.1d. The requirements in AISC 360-16 are:

“Built-up cross sections consisting of plates with a thickness exceeding 2 in. (50 mm) are considered built-up heavy shapes. Built-up heavy shapes used as members subject to primary (computed) tensile forces due to tension or flexure and spliced or connected to other members using complete-joint-penetration groove welds that fuse through the thickness of the plates, shall be specified as follows. The structural design documents shall require that the steel be supplied with Charpy V-notch impact test results in accordance with ASTM A6/A6M, Supplementary Requirement S5, Charpy V-Notch Impact Test. The impact test shall be conducted in accordance with ASTM A673/A673M, Frequency P, and shall meet a minimum average value of 20 ft-lb (27 J) absorbed energy at a maximum temperature of +70 °F (+21 °C).”

The ASTM standards referenced in this section require that three CVN specimens be taken at the quarter-thickness of one end of every plate and tested at the specified temperature to demonstrate an average impact energy that equals or exceeds the specified value, which was 20 ft-lb in this case. The 4-in. thick steel plates that fractured at the TTC met these requirements for a test temperature of 70 °F. However, the extensive CVN testing conducted by LPI on samples removed from the girders showed a significant drop in CVN values in going from quarter-thickness of the plate (the specified testing location) to mid-thickness of the plate (the location of fracture initiation). Many of the mid-thickness CVN values at 70 °F were under 10-ft-lbs. At 30 °F, almost all mid-thickness CVNs were on the order of 3 to 7 ft-lbs. These very low CVN values at mid-thickness of the bottom flange plates of the TPG3 girders played a significant role in the fractures. In the view of the authors, materials of such low fracture toughness substantially increase the likelihood of brittle fracture and should not be allowed in critical structural applications for details susceptible to brittle fracture, such as those described in Section A3.1d. of AISC-360.

Further, the CVN testing conducted by LPI showed a large variability in the measured CVN values. For example, the CVN values for mid-thickness samples taken from the Fremont Street girders ranged from 5 ft-lbs to 39 ft-lbs at 70 °F. This large variability calls into question whether three samples are adequate to properly assess CVN impact energy.

AISC 360 requires CVN testing to be conducted at a maximum temperature of 70 °F. Most steel structures are within a heated enclosure once construction is completed; however, building structures are exposed to ambient temperatures during construction. Further, some structures or portions of structures, such as the TTC, are exposed to ambient

temperatures during their service life. While the commentary to AISC 360 briefly addresses this issue, additional specification guidance would be beneficial in determining when a lower test temperature is appropriate and how the test temperature should be selected.

Recommendations

The authors recommend:

- That AISC 360 re-evaluate the standard quarter-thickness sampling location for CVN testing, considering the very low mid-thickness CVN values found in the fractured flanges of the TTC girders. Serious consideration should be given to changing the required sampling location to mid-thickness for details that may be susceptible to brittle fracture. This is analogous to the AISC requirement for special CVN testing of the core area of jumbo rolled sections;
- That AISC 360 re-evaluate the required number of CVN samples. The large variability in the measured CVN values seen in the TTC girders suggests that three samples may not be adequate to provide a statistically meaningful result; and
- That AISC 360 provide guidance on establishing CVN test temperatures for structures exposed to ambient temperatures, either during construction and/or during the service life of the structure.

2. Requirements for Thermally Cut Penetrations and Reentrant Corners

A factor contributing to the brittle fractures at the TTC was the hard layer of martensitic material at the surface of the secondary slots that formed because of the thermal cutting of these slots. Microcracks formed in this hard layer at the radii of the reentrant corners of the secondary slots due to a stress concentration effect at this location. These microcracks subsequently developed into larger pop-in cracks that initiated the brittle fractures. This condition was exacerbated by the proximity of the reentrant corners of the secondary slots to the CJP groove weld in the flange.

Both AISC 360 as well as the *AWS Structural Welding Code-Steel* (AWS D1.1) provide some guidance on when grinding is required for thermally cut surfaces in thick materials to remove hard surface layers and to remove microcracks, to reduce the likelihood of brittle fracture. More specifically, these standards require thermally cut surfaces of weld access holes in thick materials to be ground to “bright metal.” Further, these standards provide dimensional requirements for weld access holes to further minimize the risk of brittle fracture.

In the case of the TTC girder fractures, questions arose about whether the secondary slots qualified as “weld access holes” and therefore subject to the dimensional requirements and surface finish and grinding requirements of AISC 360 and AWS D1.1.

Further, there may be other situations in structures where penetrations and reentrant corners are thermally cut in thick materials and where the dimensional and surface finish requirements are unclear from the current provisions in AISC 360 and AWS D1.1. Also, it is unclear if the requirement to grind to “bright metal” is adequate to assure removal of a hard surface layer and surface microcracks.

Recommendations

The authors recommend:

- That AISC 360 and AWS D1.1 clarify the definition of the term “weld access hole” to include only those details required to accommodate welding as illustrated in the commentary of AISC 360 and as illustrated in AWS D1.1. These standards currently provide dimensional requirements, surface roughness and grinding requirements, and inspection requirements. Where needed, these standards should also provide requirements or guidance on the preferred sequence of assembly, cutting, welding, and inspection;
- That AISC 360 consider other thermally cut surfaces in thick materials at reentrant corners and other areas of stress concentration, including those that may or may not be associated with welding, and provide guidance on appropriate dimensional requirements, surface roughness, finish and/or grinding requirements, and inspection requirements. Also, where pertinent, these standards should provide requirements or guidance on the preferred sequence of assembly, cutting, welding, and inspection. Examples in the TTC are the primary slots and the secondary slots in the bottom flanges of the TPG3 girders. The primary slots, which were thermally cut and contain reentrant corners, were provided to allow the hanger connection plate to pass through the bottom flange, not to accommodate welding. The secondary slots were made to remove possible existing weld discontinuities or to provide space for weld tabs at the end of the splice groove welds. Other reentrant corners include corner copes for stiffeners or continuity plates, corners at the edges of connection materials, and other openings; and
- That AISC 360 and AWS D1.1 re-evaluate whether the requirement to grind to “bright metal” is adequate to ensure removal of hard surface layers and microcracks on thermally cut surfaces in thick materials at locations of stress concentration, such as reentrant corners.

3. Development of a Risk Assessment Approach for Brittle Fracture

The recommendations made above regarding material CVN testing and regarding requirements for thermally cut penetrations and reentrant corners are a direct result of lessons learned from the fractured girders at the TTC. This final recommendation is based not only on lessons learned from the TTC but also on a broader perspective on brittle fracture risk.

Brittle fracture risk is based on the combination of likelihood and consequence of the event occurrence. The likelihood of brittle fracture is affected by several interrelated factors involving materials, fabrication, design, and detailing. These factors include:

- Susceptible material with low fracture toughness, particularly near the mid-thickness region of thick materials, as may be affected by steel compositions, steel manufacturing methods, low service temperatures, fast loading rates, or local degradation from other operations such as forming or excessive heating;
- Susceptible material at a local level, such as hard, brittle martensite that is formed by the rapid cooling of the surface of thermal cut edges;
- Sufficient stress, which may be from applied loads and/or from residual stresses generated by weld shrinkage, thermal heating, thermal cutting, or by forming;
- Geometric stress concentrations such as reentrant corners and transitions, whether square or with a radius;
- Initiating flaws such as cracks, both micro and macro, and inclusions or notches that serve as significant stress concentrations; and
- Constraint, inherent with thick material but also created by triaxial and biaxial intersecting welds, that limits or prohibits the material from performing in a ductile manner, necessary for redistribution of stress.

The occurrence of brittle fracture requires that several of the factors listed above be present simultaneously and with sufficient severity. Consequently, there are tradeoffs between these factors. As described earlier, steel with higher fracture toughness can tolerate larger discontinuities and larger stresses. Likewise, elements with smaller discontinuities and smaller stress levels can permit the use of steel with lower fracture toughness, etc. A variety of solutions are therefore possible for minimizing the occurrence of brittle fracture.

A design and construction standard should permit selection from a variety of available solutions that provide alternatives and flexibility to address the various factors that contribute to brittle fracture risk. A holistic risk assessment approach can provide a useful framework to inform such decisions. Such an approach considers how causative factors combine to increase or decrease the likelihood of brittle fracture, and possible consequences of brittle fracture based on importance of the structure, structural function of the member, and redundancy.

The International Institute of Welding (IIW) developed a simplified risk assessment approach for seismic-resistant moment connections entitled: "IIW Recommendations for Assessment of Risk of Fracture in Seismically Affected Moment Connections." While this document is intended for seismic applications, it can potentially serve as a model for a broader-based risk assessment approach for design decisions related to brittle fracture.

Recommendation

The authors recommend that AISC, working in conjunction with industry stakeholders, consider developing a risk assessment approach for brittle fracture. Such an approach could be presented in a design guide and/or incorporated into AISC 360 and other appropriate standards. AISC should consider “IIW Recommendations for Assessment of Risk of Fracture in Seismically Affected Moment Connections” as a potential model for a broader-based brittle fracture risk assessment approach.

Acknowledgements

The authors of this document acknowledge the cooperation of the TJPA and its project team and consultants in the full course of the investigation of the brittle fractures at the TTC.